



12V7.0AH



Features:

- ▲ Maintenance-free operation
- ▲ Stable quality and high reliability
- ▲ Compact design
- ▲ 10 years design time (at 25°C)

Applications:

- ♣ UPS
- ♣ Emergency lighting
- ♣ Solar panel system
- ♣ Alarm and security system
- ♣ Telecommunication system
- ♣ Fire alarm and security systems
- ♣ DC power supply Auto control system
- ♣ Backup power for testing and measuring instruments
- ♣ Electronic apparatus and equipment Communication power supply
- ♣ etc

Specifications:

Type	Specification
Nominal Voltage	12v(6cells)
Nominal Capacity	7.0ah (20hrs, 25°C/77°F)
	6.85ah (10hrs, 25°C/77°F)
	3.90ah (1hrs, 25°C/77°F)
Dimension	Length: 151±2mm
	Width: 65±2mm
	Container Height: 95±2mm
	Total Height(with Terminal):102±3mm
Approx Weight	2.05kg
Terminal	F1 or F2
Container material	ABS
Max.Discharge Current	800A(5s)
Internal Resistance	Approx 46mΩ
Operation Temp.Range	Discharge:-15-50°C(5-122°F)
	Charge: 0-40°C(32-104°F)
	Storage: -15-40°C(5-104°F)
Nominal Operating Temp.Range	25±3°C(77±5°F)
Cycle Use	14.4V-15.0V(25°C/77°F) Coefficient:30mv/°C (Initial charging current less than 1.95A)
Standby Use	13.5V-13.8V(25°C/77°F) Coefficient:20mv/°C (No limit on Initial Charging Current)
Capacity affected by Temp.	103% 40°C(104°F)
	100% 25°C(77°F)
	86% 0°C(32°F)

Self Discharge:

KANGLIDA batteries maybe stored for up to 6months at 25°C(77°F) and then a freshing charge is required, for higher temperatures the time interval will be shorter.

Capacity after storage	1month	3month	6month	12month
Self-discharge 25°C(77°F)	98%	95%	87%	65%

Note: the above characteristics data are average values obtained within three charge/discharge cycles, not the minimum values.

Dimensions:

• Outer dimensions(mm)

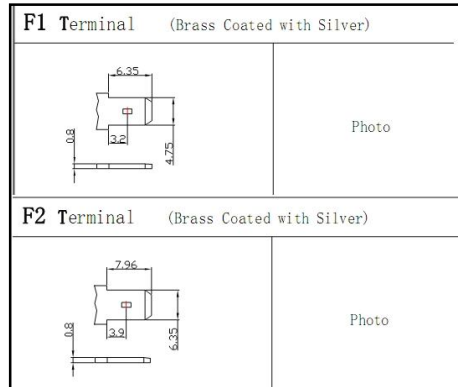
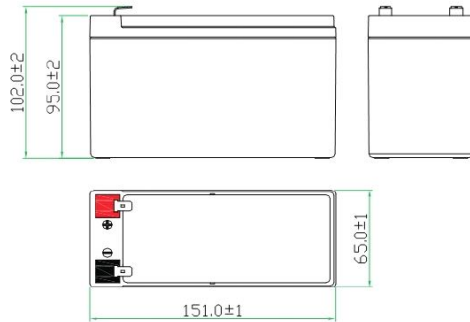

Characteristics:

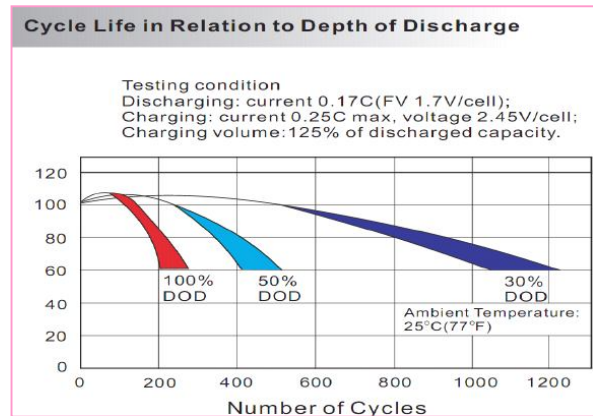
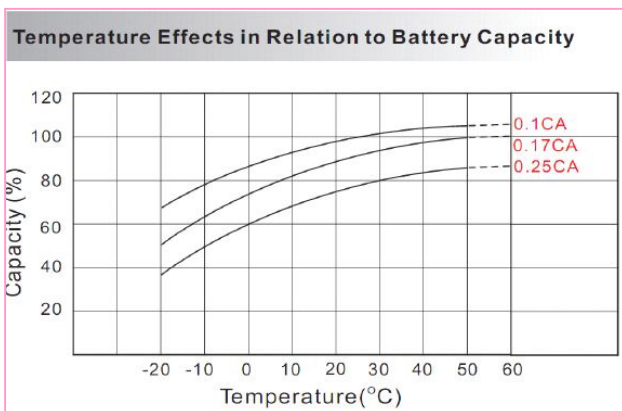
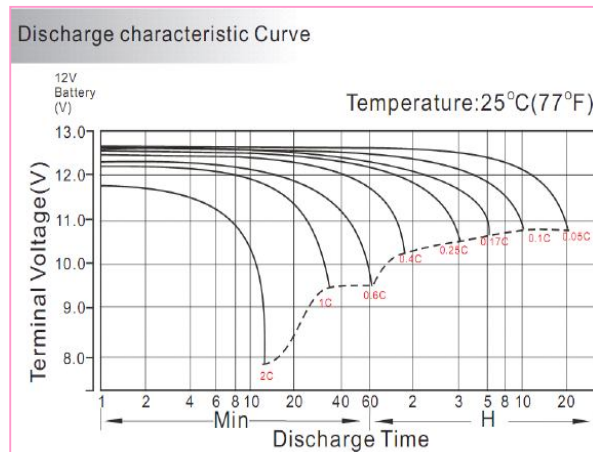
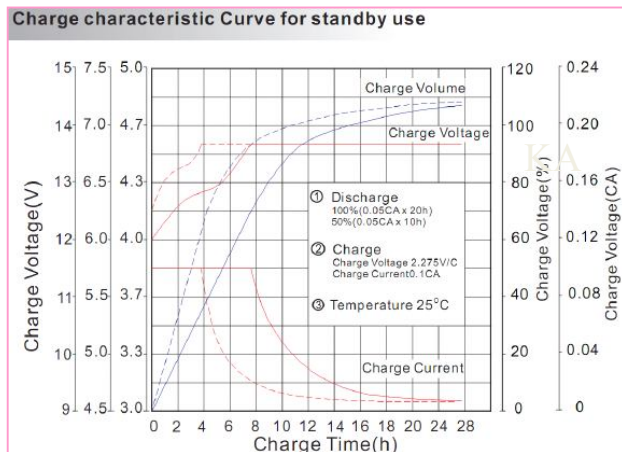

Storage characteristics

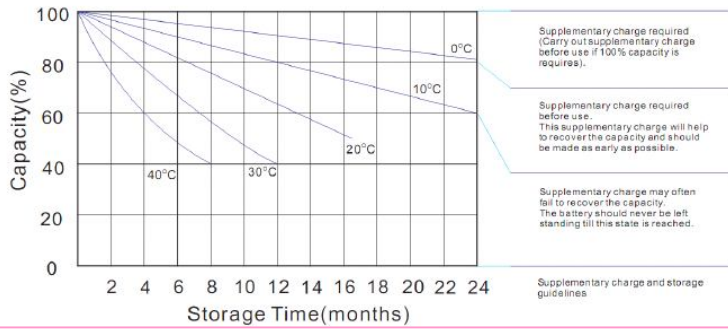

Effect of temperature on long term float life

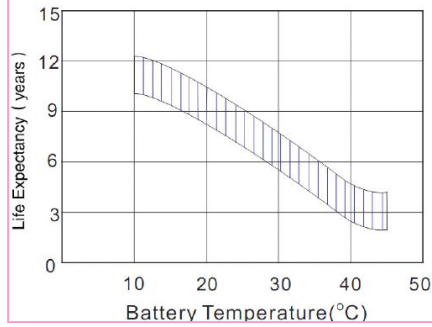

Maintenances and Attentions:

1. After received product, please checked box damaged or not, if find crack on battery body, contact with us and logistics, it should be caused by boorish handle during delivery;
2. Don't pull or shake terminal, otherwise, it may cause terminal loosen;
3. Battery is not allowed close to Tepid source or basked under the sun for a long time;
4. Charge in the obturate container is not allowed;
5. No short circuit. Battery should be stored full of electronic when not in need, and the battery should be charged every three months in order to avoid the irreversible sulphation. When battery case bursts or electrolyte leaks, battery should be changed lest the acid corrosion.
6. No battery in environment with the acid gas.
7. When battery is used as the backup battery, be careful and check it at regular time to avoid the damage battery. Especially the battery beyond one year should be checked in time, and change the less capacity and scrapped battery. (some batteries maybe have voltage but no current; some batteries maybe have current but no voltage; some maybe have both but less capacity; all these conditions cannot meet the work, reach the power-on time. Do not forth small battery, cause the huge losses)
8. Forbidden put battery in the fire, otherwise it will cause an explosion.
9. When battery cracks or leaks, please use cotton cloth clean it. When skin contacts to the liquid, wash with fresh water immediately. See doctor if serious.
10. No wash on the surface of the battery with the organic solution.

