



6V1.3AH



Features:

- ▲ Maintenance-free operation
- ▲ Stable quality and high reliability
- ▲ Compact design
- ▲ 10 years design time (at 25°C)

Applications:

- ♣ UPS (Uninterruptable Power System)
- ♣ Fire alarm and security systems
- ♣ Emergency lighting
- ♣ DC power supply Auto control system
- ♣ Solar panel system
- ♣ Backup power for testing and measuring instruments
- ♣ Alarm and security system
- ♣ Electronic apparatus and equipment Communication power supply
- ♣ Tele-communication system
- ♣ etc

Specifications:

Type	Specification
Nominal Voltage	6v
Nominal Capacity	1.3ah
Dimension	Length: 97±3mm
	Width: 24±3mm
	Container Height: 51±3mm
	Total Height(with Terminal):55±3mm
Approx Weight	0.26kg
Terminal	F1
Container material	ABS
Rated Capacity	1.3ah/170.0mA (20hrs, 25°C/77°F)
	1.1ah/340.0mA (10hrs, 25°C/77°F)
	1.0ah/530.0mA (5hrs, 25°C/77°F)
	0.7ah/2000.0mA (1hrs, 25°C/77°F)
Internal Resistance	Approx 65mΩ
Operation Temp.Range	Discharge:-15-50°C(5-122°F)
	Charge: 0-40°C(32-104°F)
	Storage: -15-40°C(5-104°F)
Nominal Operating Temp.Range	25±3°C(77±5°F)
Cycle Use	7.2V-7.5V(25°C/77°F) Coefficient:30mv/°C (Initial charging current less than 0.39A)
Standby Use	6.75V-6.90V(25°C/77°F) Coefficient:20mv/°C (No limit on Initial Charging Current)
Capacity affected by Temp.	102% 40°C(104°F)
	100% 25°C(77°F)
	80% 0°C(32°F)

Self Discharge:

KANGLIDA batteries maybe stored for up to 6months at 25°C(77°F) and then a freshing charge is required, for higher temperatures the time interval will be shorter.

Capacity after storage	1month	3month	6month	12month
Self-discharge 25°C(77°F)	90%	75%	65%	55%

Note: the above characteristics data are average values obtained within three charge/discharge cycles, not the minimum values.

Dimension:

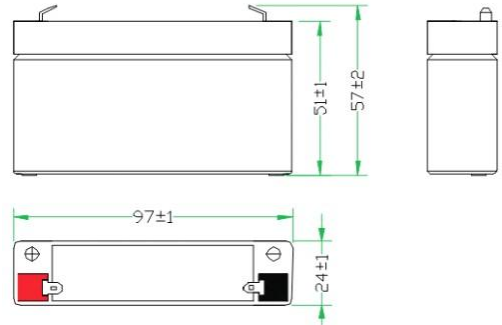
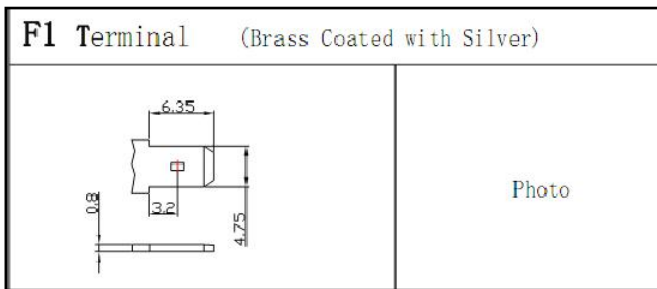

Characteristics:

Charge characteristic Curve for standby use

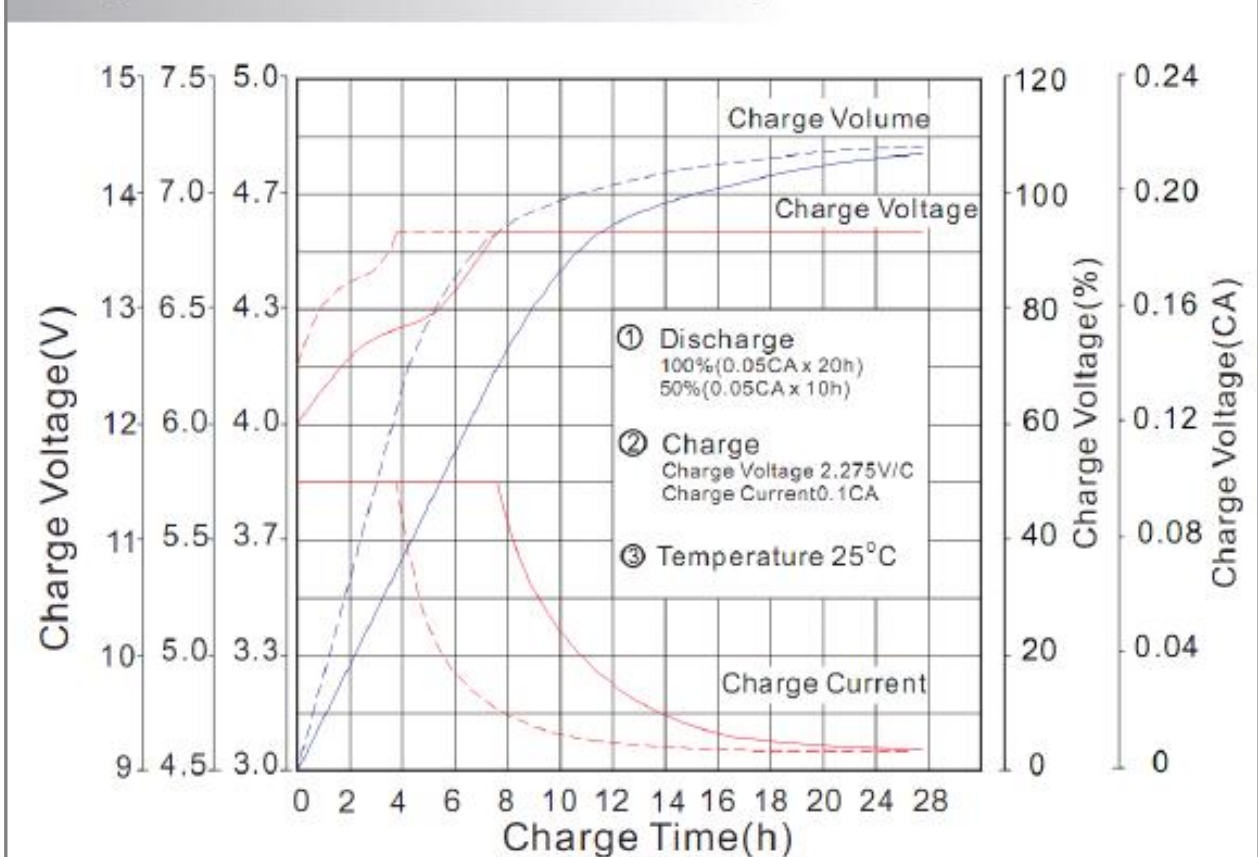

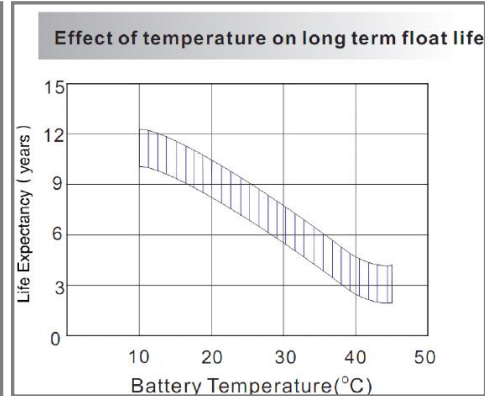
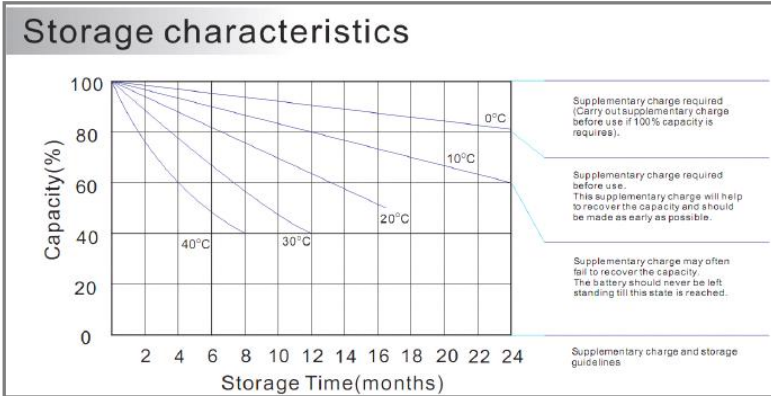
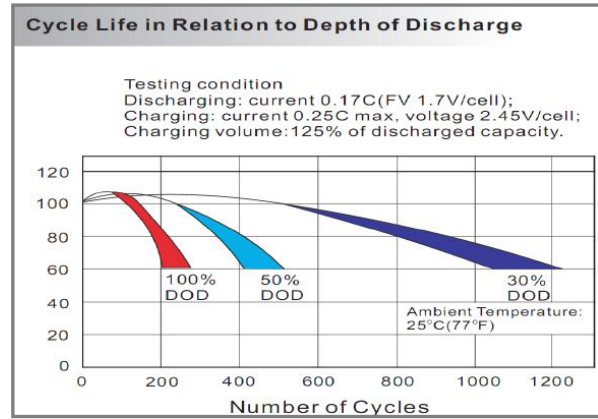
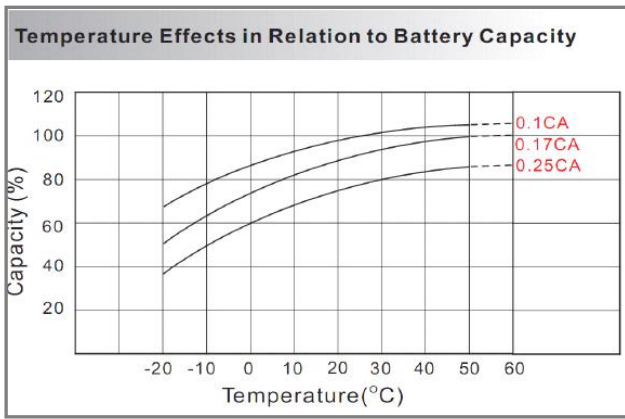

Attentions:

1. After received product, please checked box damaged or not, if find crack on battery body, contact with us and logistics, it should be caused by boorish handle during delivery;
2. Don't pull or shake terminal, otherwise, it may cause terminal loosen;
3. Battery is not allowed close to Tepid source or basked under the sun for a long time;
4. Charge in the obturate container is not allowed;
5. No short circuit. Battery should be stored full of electronic when not in need, and the battery should be charged every three months in order to avoid the irreversible sulphation. When battery case bursts or electrolyte leaks, battery should be changed lest the acid corrosion.
6. No battery in environment with the acid gas.
7. When battery is used as the backup battery, be careful and check it at regular time to avoid the damage battery. Especially the battery beyond one year should be checked in time, and change the less capacity and scrapped battery. (some batteries maybe have voltage but no current; some batteries maybe have current but no voltage; some maybe have both but less capacity: all these conditions cannot meet the work, reach the power-on time. Do not forth small battery, cause the huge losses)
8. Forbidden put battery in the fire, otherwise it will cause an explosion.
9. When battery cracks or leaks, please use cotton cloth clean it. When skin contacts to the liquid, wash with fresh water immediately. See doctor if serious.
10. No wash on the surface of the battery with the organic solution.
11. If the equipment uses batteries in groups, the batteries must be selected with similar voltage before usage, otherwise some batteries in the group will be damaged due to inconsistent voltage and internal resistance.
12. In the process of recycling the battery, do not use it under the state of dissatisfied charging. As a result, the battery will be sulphated, and the storage performance and capacity will drop to a long-term dissatisfied state; the battery's capacity and efficiency of use will not be obtained.

Zhengzhou Kanlida electronic power Co., LTD

ShenZhen Kanlida electronic power Co., LTD

<http://www.kldbattery.com>

 <http://www.com-battery.com>

 <http://www.comkanlida.com>

 <http://www.kldbatteries.com>

 <http://www.kanlidabatteries.com>

Email: paulali@cnbattery.cn

Email: demi@cnbattery.cn

Tel: 86-371-68786444 / 86-755-22319878